

# HPW

## HYDRAULIC HIGH PRESSURE WATER PUMPS

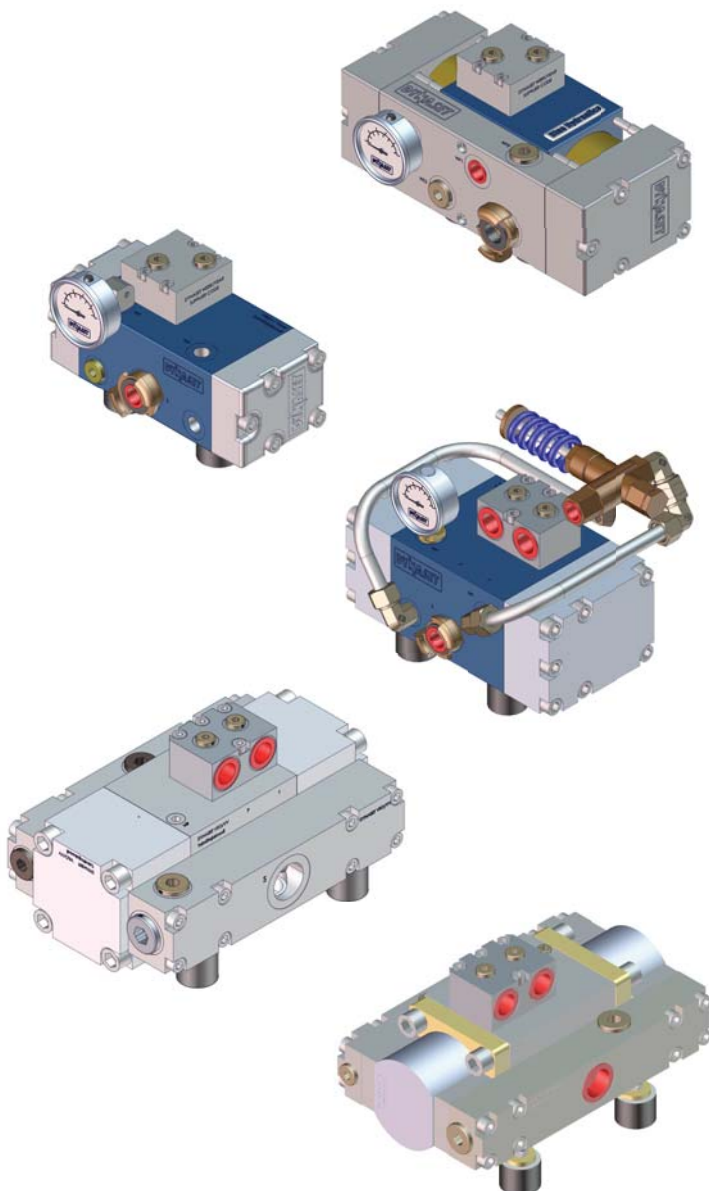

HPW 200/30-45 (-ST)	
HPW 420/20-50 (-PA)	
HPW 40/40-8	
HPW 220/50-70 (-PA)	
HPW 520/30-85 (-PA)	
HPW 90/150-85 (-PA)	
HPW 180/90-115 (-PA)	
HPW 460/50-115 (-PA)	
HPW 130/180-140 (-PA)	
HPW 800/30-140 (-LS)	
HPW 1000/30-140	
HPW 1600/15-140	
HPW 300/300-350	
HPW 1200/100-390	

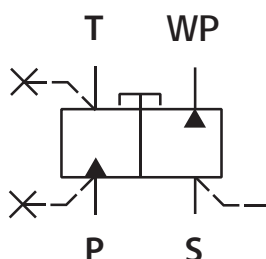

## OPERATING INSTRUCTIONS

DEAR CUSTOMER!

Thank you for choosing Dynaset product from Finland. We appreciate your product expertise and are convinced our product is efficient and profitable for you.

This product is high technology design with latest hydraulic R&D knowledge bringing high performance in compact size, providing long lasting reliable use for customers all over the world.

## TABLE OF CONTENTS

1. SAFETY PRECAUTIONS AND WARNING STICKERS	3
2. GENERAL NOTES	4
3. INSTALLATION	4-5
4. HPW INTEGRATION INTO A HYDRAULIC CIRCUIT	5-6
4.1 HPW in system with constant displacement hydraulic pump	5
4.2 Hydraulic system with variable displacement pump	6
5. OPERATION	7
5.1 Pump start-up	7
5.2 Adjusting flow rate and pressure of pumping fluid	7
5.3 Stopping HPW-pump	7
6. BASIC APPLICATIONS OF HPW-PUMP	8-10
6.1 High pressure washing with a spray gun	8
6.2 Pipeline sewer cleaning equipment	9
6.3 Street washing units	9-10
7. HYDRAULIC FLUIDS	11
8. PUMPING FLUIDS	11
9. MAINTENANCE	11
10. PRODUCT DISPOSAL	12
11. TROUBLE SHOOTING	13-15
12. TECHNICAL SPECIFICATIONS	16
13. MANUFACTURER'S LIMITED WARRANTY	17
14. DECLARATION OF CONFORMITY	18

**SAFETY PRECAUTIONS**

Operating with DYNASET HPW high pressure pump user has to conform to all safety regulations concerning pressurized equipment. Hydraulic circuit has a high pressure 210 bar.

EQUIPMENT TECHNICAL CONDITION HAS TO PAY SPECIAL ATTENTION.

In order to avoid accidents all operators and maintenance personnel must act in compliance with the laws, regulations and recommendations the high pressure hydraulics, electricity and work safety issued by local authorities.

EXTERME CLEANLINESS MUST BE MAINTAINED WHEN CARRYING OUT ANY DISSASSEMBLING OR REPAIR OF HPW-UNIT AND HYDRAULIC SYSTEM. THIS IS CRUCIAL TO ENSURE SAFE, RELIABLE AND LONG-LIFE OPERATION OF YOUR EQUIPMENT.

The pressure in hydraulic fluid circuit is considerably high and hydraulic system has to maintain regularly. Especially couplings, valves and hoses have to be tight and clean as well as kept under constant observation. Check and fix possible leakages of pressure and hot blowouts immediately avoiding user and bystander injuries.

In order to exclude possible accidents, it is not allowed to clean or inspect HPW unit when hydraulic fluid circuit is pressurized. Prior to any cleaning, inspection and service hydraulic system of your carrier machine must be stopped and all hydraulic fluid circuits depressurized.

Wear appropriate clothing and safety equipment such as goggles, ear and eye protection, safety shoes at all times when operating by the HPW pump. Beware of machinery parts are warm by hot hydraulic oil.

Operators and maintenance personnel must always comply with local safety regulations and precautions in order to close out the possibility of damages and accidents.

All installation and service of both hydraulic and electric equipment must be performing experienced personnel only.

Preventing freezing nozzles, water circuit and pipeline. Draining and air flushing have to perform before ambient temperature reaches 0°C or lower.

**WARNING STICKERS**

Dynaset dispatch department includes one (1) warning sticker bag per one (1) main product. Product recipient is obligated to fix determinate warning sticker to Dynaset product. Attach sticker to visible and appropriate place or close to Dynaset product where it's easily seen. Before attaching sticker clean surface with solvent detergent.



READ OPERATING INSTRUCTIONS.



BEWARE OF HIGH PRESSURE  
SPLATTERS.



KEEP FROM FREEZING.



USE EAR PROTECTOR AND  
GLOGGLES.

## GENERAL NOTES

DYNASET HPW-pump is a converter, which transforms actuating fluid power, usually hydraulic oil, into pumping fluid's power, which is defined by flow rate and pressure. Actuating power is supplied from hydraulic system of carrier machine or other installation. Water or any other pumping fluid can be taken from natural source, reservoir or pressurized supply network.

The patented HPW-pump utilizes the reciprocal motion of hydraulic piston, when two water plungers, flanked to it, develop pressure in delivery (pressure) line. Hydraulic flow moves the piston assembly until the other water plunger reaches its extreme position, when changes the incorporated reversal valve direction of hydraulic flow and, by that, the piston assembly is being set to counter direction. Vacuum is being developed into pumping fluid's intake line and positive pressure in delivery line accordingly. Within pumping cycle water (or other pumping fluid) is being taken by water plungers through intake valves and pumped through pressure valves into delivery line.

Relation of pumping fluid's flow rate and pressure to corresponding parameters of hydraulic fluid is linear, as shown on diagrams below.

When hydraulic pressure and/or flow is under the value needed to achieve the maximum output power of HPW-pump, the water pressure and flow are decreased respectively without any harm to pump itself.

### ATTENTION !

Most of HPW-pumps are self-priming. Specific characteristics of any pump can be verified according to the technical specification (see last page).

THE DESIGN OF HPW-PUMP IS PROTECTED WITH THE INTERNATIONAL PATENT.

## PUMPING FLUID TO HYDRAULIC FLUID RELATION, CONCERNING THEIR FLOW RATES AND PRESSURE.

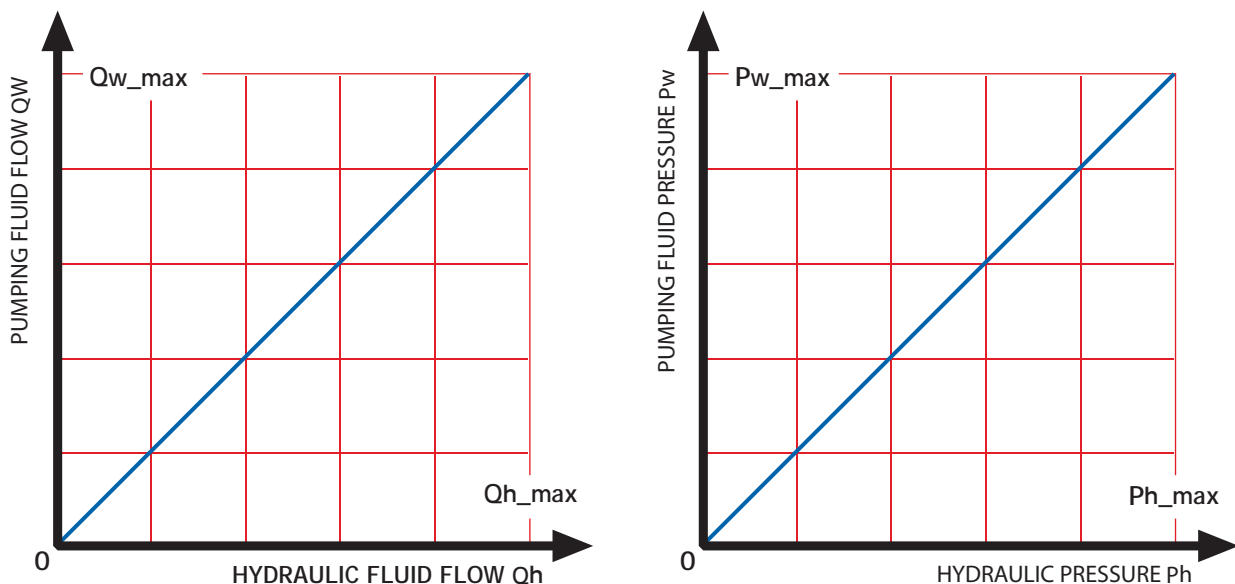

## INSTALLATION

DYNASET HPW-pumps are compact and integrated all-in-one units, designed for both mobile and workshop installation. HPW-pumps perfectly work installed on excavators, mining machines, tractors, trucks and vans. In workshop use HPW-pump is accompanied with hydraulic aggregate.

DYNASET HPW-pump can be positioned deliberately, keeping in view following preconditions:

1. Easy service access to the unit should be ensured.
2. Pump should be mounted on sufficiently horizontal surface to enable proper working of leakage detecting bores, which are found either on bottom surface or side faces of pump housing (depends on model). Leakage detecting bores are made to the zones, which separate oil and water chambers from each other.

If the draining from leakage detectors exceeds rate of 10 drops per minute, pump sealings should be replaced. The drain fluid can be water, hydraulic oil or their solution.

You can choose deliberately how to make pump's installation to your carrier: either fixed or as a quick release unit. In latter case HPW-pump is easily detached and re-attached to carrier's hydraulic system with quick couplings, when pump can be moved from one carrier to another when necessary.

## ... INSTALLATION

## LEAKAGE DETECTORS IN DIFFERENT HPW-MODELS

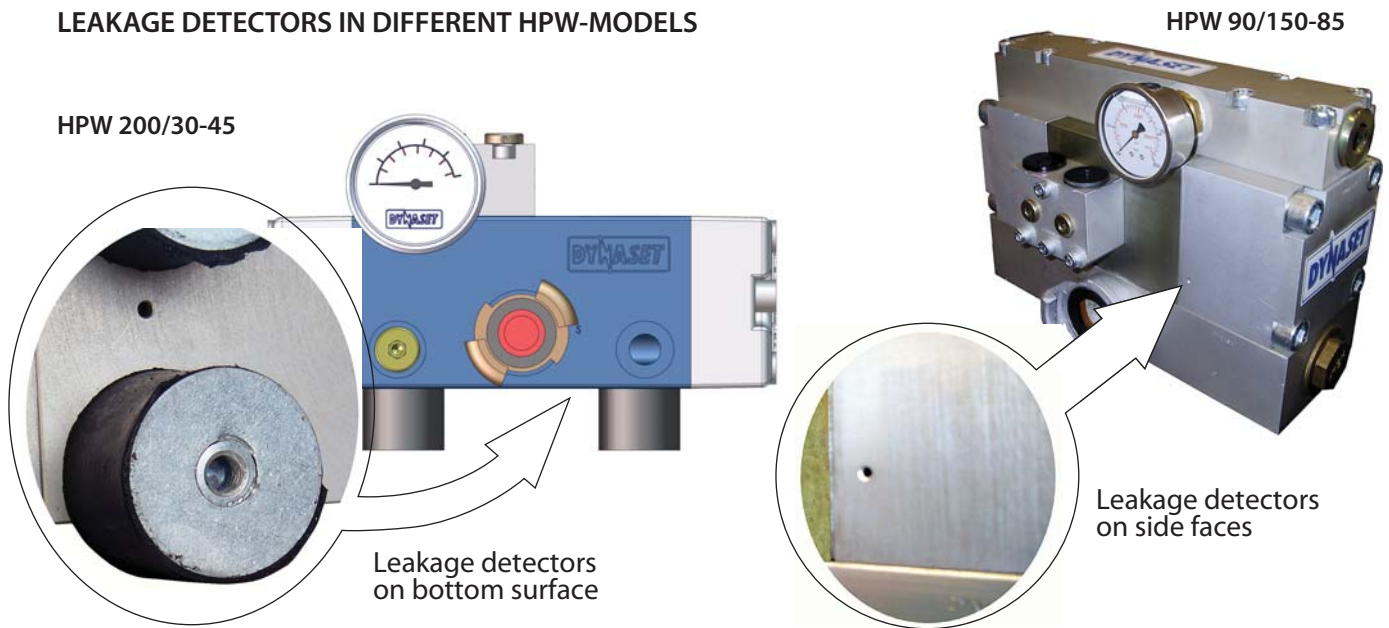

## INTEGRATION INTO A HYDRAULIC CIRCUIT

HPW-pump is to be connected to hydraulic system of carrier machine, as well as to pumping fluid circuit. HPW can be installed with no particular efforts to system based on either constant or variable displacement hydraulic pump, as well as to closed hydraulic systems.

## 1. HYDRAULIC SYSTEM WITH CONSTANT DISPLACEMENT PUMP:

The required oil flow is set by correct dimensioning of the hydraulic pump and keeping the demanded rotation speed or, alternatively, with pressure compensated 3-way valve.

## 2. HYDRAULIC SYSTEM WITH VARIABLE DISPLACEMENT PUMP:

- .1 In system with OPEN CENTRE the required oil flow is set by DYNASET PRESSURE COMPENSATED PRIORITY VALVE
- .2 In system with CLOSED CENTRE (load sensing system) the required oil flow is set by DYNASET LS-VALVE kit, which comprises solenoid valve, pressure compensated oil flow limiter and pressure relief valve.

## HPW IN SYSTEM WITH CONSTANT DISPLACEMENT HYDRAULIC PUMP

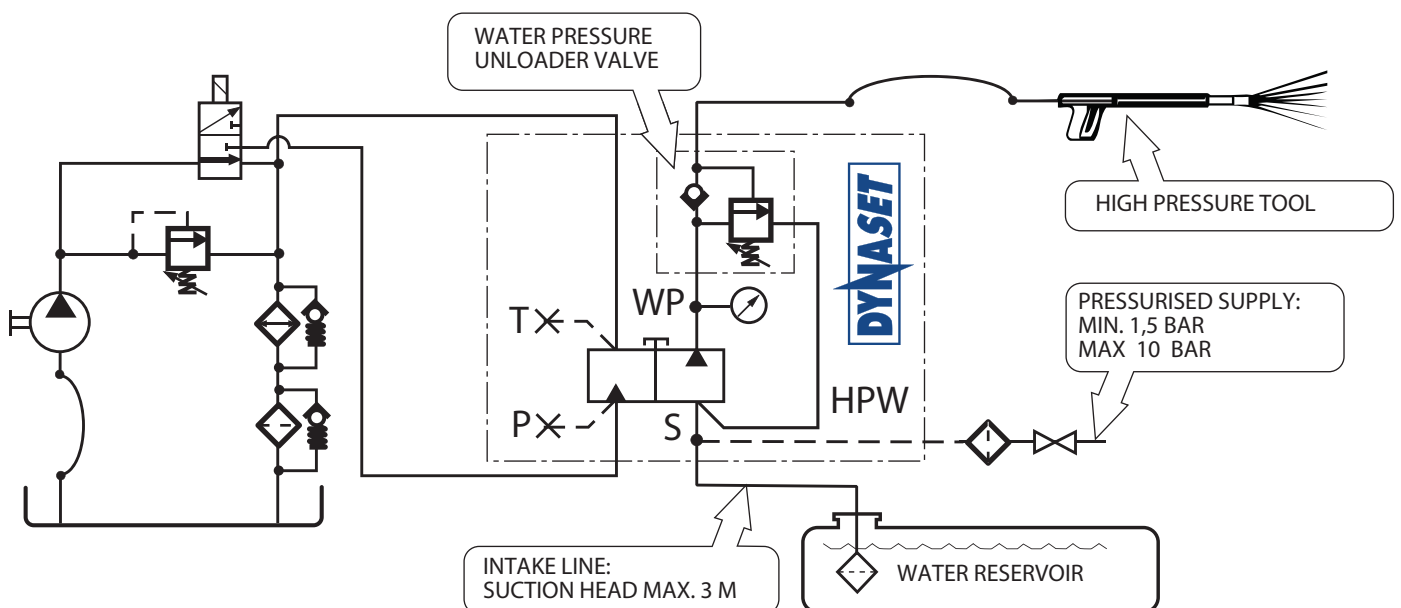

## ... INSTALLATION

## HPW IN SYSTEM WITH VARIABLE DISPLACEMENT HYDRAULIC PUMP

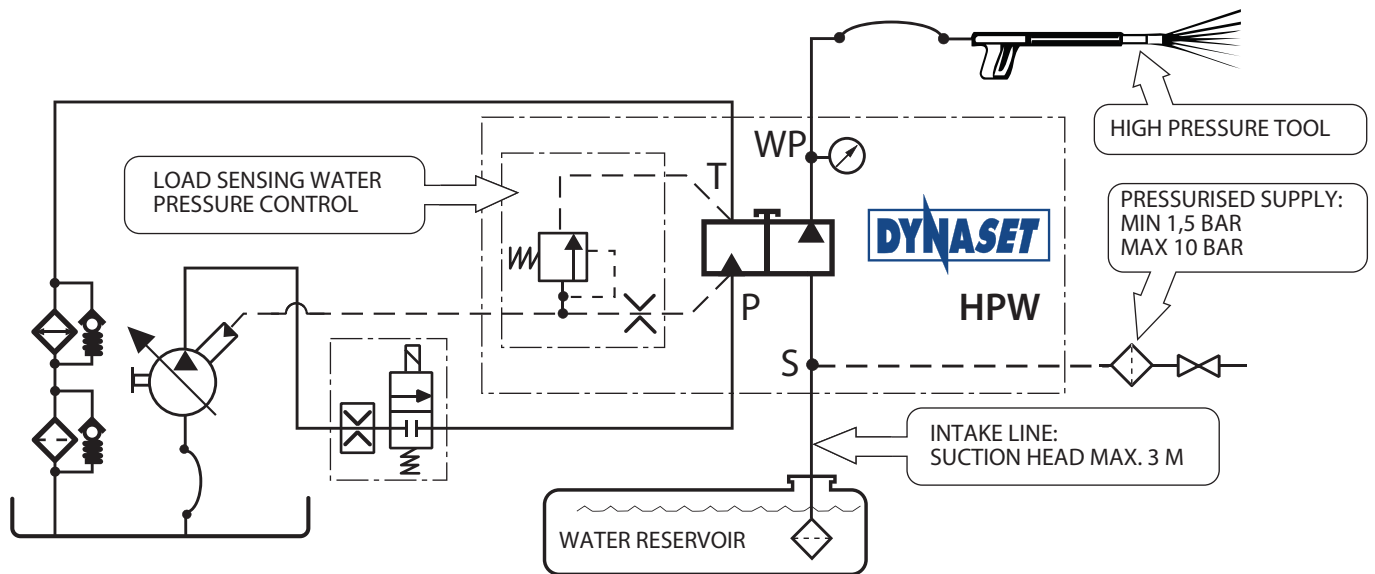

## HPW HYDRAULIC PORTS:

**Pressure P**, the pressure line is to be attached to;  
**Return T**, the runback line is to be attached to.

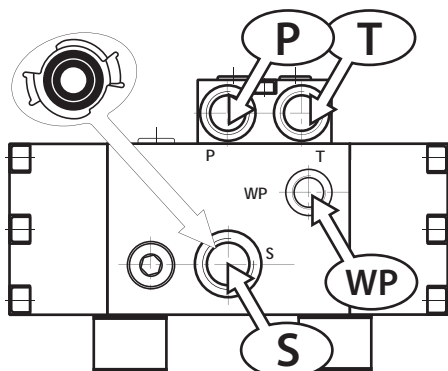

HPW-PUMP WITHOUT WATER  
PRESSURE UNLOADER VALVE

## HPW' WATER PORTS:

**INTAKE S**, the water supply line is to be attached to;  
**WATER PRESSURE WP**, the delivery (pressure) line is to be attached to.

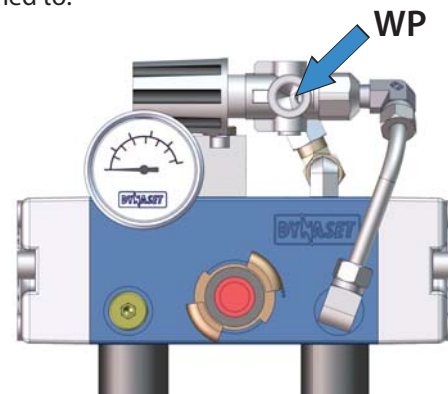

HPW-PUMP EQUIPPED WITH WATER  
PRESSURE UNLOADER VALVE

## ATTENTION !

Check the ports of your HPW-pump and connect it to hydraulic and pumping fluid circuits according to their markings !

1. If the hydraulic pressure line will be connected by accident to the return port and return line correspondingly to the pressure port, it will not cause any harm to HPW-pump, however pump will not operate.
2. Output power of HPW-pump depends on the pressure difference between pressure and return lines. The more is the pressure in return line, the less is concerned pressure difference and output power of the pump. The fact should be taken into account when certain number of machines are intended to be joined-up in series.
3. Since the piston assembly reverses extremely rapidly (refer to the TECHNICAL SPECIFICATIONS), certain oscillation can be imposed to the return line because of pressure pulsation. In order to reduce both pressure pulsation and return line oscillation, the flexible hose with textile fabric cord is recommended to be used in return line to protect from damage low pressure units, such as oil cooler.
4. Prior to connecting HPW-pump to hydraulic circuit, compatibility of used equipment should be ensured. Hydraulic pressure and flow rate produced by hydraulic circuit should meet values demanded by your HPW-pump. Refer to the technical specifications.

Prior to starting-up the HPW-pump it is checked whether all couplings in hydraulic and pumping fluid circuits are properly connected and there are no leakages over the equipment. Ensure that the water tank is refilled and intake line's strainer/filter is clean. If water (or any other pumping fluid) is taken from pressurized supply, ensure that the shut-off valve is open.

### PUMP START-UP

HPW-pump starts immediately after the hydraulic flow has been put on either with control valve (manual or solenoid) and/or by pulling the trigger of spray gun. Immediately after opening the water pressure line, air is being vented out from the pumping fluid circuit and high pressure washing is about to begin!  
**DO NOT TRY WITH HAND THE WATER OR AIR COMING OUT FROM HIGH PRESSURE NOZZLE!**

The nozzle, attached to a pressure tool, determines the flow rate and pressure of water when operating parameters of hydraulic circuit meet HPW-pump's requirements. In other words, even your HPW-pump fits perfectly to hydraulic system and does well with the job, dimensioning of the pressure tool should never be underestimated as a very important step for ensuring the optimal water jet or hydro-demolition power in each application.

### ADJUSTING FLOW RATE AND PRESSURE OF PUMPING FLUID

When the HPW-pump is equipped WITH WATER PRESSURE UNLOADER VALVE:

1. The valve afore is for adjusting the pressure and flow rate of water or any other pumping fluid. Boosting the pressure increases flow rate and vice versa.
2. After closing water pressure line, whereupon the adjusted pressure limit is being reached, water pressure unloader valve puts the water to free circulation mode.

When the HPW-pump is installed WITHOUT WATER PRESSURE UNLOADER VALVE:

1. Pressure and flow in pumping fluid circuit are adjusted by adjusting corresponding parameters in hydraulic circuit.
2. In circuits based on constant displacement pump closing the water pressure line opens the pressure relief valve in hydraulic system. **IS TO BE KEPT IN MIND THAT HYDRAULIC FLUID CIRCULATION THROUGH PRESSURE RELIEF VALVE CAUSES HEATING OF HYDRAULIC SYSTEM!**
3. In circuits based on variable displacement hydraulic pump closing the water pressure line adjusts pump's swashplate at 0° angle when hydraulic pump produces flow only for self-lubrication and self-flushing. Pressure control must be fast enough to protect HPW-pump from pressure peaks or the hydraulic system must be provided with pressure peak limiter.

### STOPPING HPW-PUMP

HPW-pump is halted by shutting off the hydraulic flow. High pressure remains in closed water delivery line, which should be depressurized to avoid unexpected water discharges. If spray gun or similar tool has been used, pull the trigger for some time after the pump has halted.

In cold season HPW-pump and pumping fluid pressure line should be dewatered after a working shift. Detach the intake hose from HPW-pump and run it for a while until all water is moved from water circuit.

**ATTENTION!** In cold season HPW-pump can be used for circulating the water through water circuit to keep it unfrozen in transit.

Different water based solutions and special liquids can be used as pumping fluid with HPW-pumps. The only requirement is that the pump **MUST** be thoroughly cleaned and flushed with sweet water after the job to prevent pump and its sealing from oxidation and water valves from seizing. The procedure should be made even if such a harmless liquid as sea water has been used.

**ATTENTION!** HPW-pump can be run dry unlimited time without any harm, because self-lubricating sealing and circulating hydraulic oil prevent the pump from overheating.

## BASIC APPLICATIONS OF HPW-PUMP

Various high pressure washing and cleaning jobs, such as spray gun washing, pipe and sewer cleaning and street washing, are typical applications of DYNASET HPW-pumps. As special applications, high pressure dust suppression, hydro-demolition and high pressure fire-fighting systems are worth to mention. Compact size and reasonable power demand enable to fit HPW-pump practically to any project, where high pressure water or other fluid is being used.

Washing power depends on both water pressure and volumetric flow. High pressure method ensures sufficient water flow at high velocity, offering in that way excellent washing power with exceptionally small water rate in contrast with traditional low pressure method. HIGH PRESSURE SAVES WATER !

### HIGH PRESSURE WASHING WITH A SPRAY GUN

Spray gun is a multipurpose high pressure tool, which is delivered either with its own HPW-based power kit for running as stand-alone package, or as optional equipment to another high pressure system. Spray gun can be fitted with various nozzles and detergent injectors depending on your task.

Three basic nozzle types are shown on the picture alongside:

1. Fan nozzle 15 – 65°;
2. Point nozzle;
3. Rotating point nozzle (turbo-nozzle).

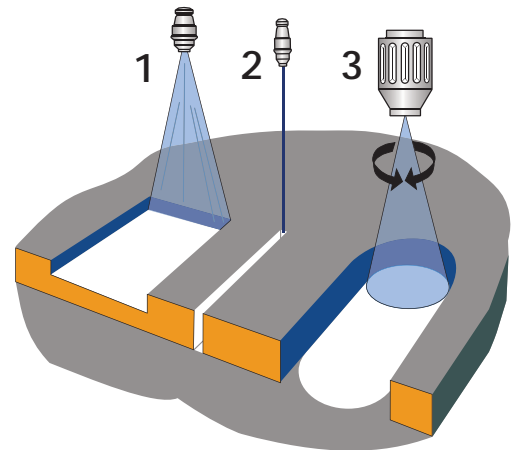

HIGH PRESSURE NOZZLE is to be chosen according to your washing task.

FAN NOZZLE is to the best advantage when quite big area should be handled in fast and efficient way.

POINT NOZZLE focuses the maximum impact to a small area, fitting perfectly in various hydro-demolitions jobs.

TURBO-NOZZLE combines advantages of both above nozzle types. It has built-in point nozzle, which is rotated by the recoil force of the side water jet. An impact efficiency of turbo-nozzle is nearly as high as point nozzle's and area coverage as big as fan nozzle's.



Spray guns for different water outputs, nozzles, high pressure hoses and wide range of accessories are available from DYNASET OY and dealers world-wide.



## ...BASIC APPLICATIONS OF HPW-PUMPS

### PIPE AND SEWER CLEANING EQUIPMENT

Equipment kit for opening and cleaning clogged pipelines and sewers is comprised of following units: DYNASET HPW-pump, DYNASET hydraulic hose reel, pressure hose of suitable length and diameter, pipe opening/cleaning multi-jet nozzle head.

1. Unlock the hose reel to enable its free rotating.
2. Put the nozzle head with attached high pressure hose into pipe you are going to wash.
3. Start the HPW-pump.

The nozzle head penetrates into pipeline due to recoil force of water jets coming out from nozzles, located on its rear rim. The water jets push the nozzle head forward and simultaneously scour the pipe. Additionally, at least one nozzle, located on the face surface of head unit, jets the water in forward direction, opening the channel for nozzle head and water hose.

The piston mode of functioning is a clear advantage of HPW-pump: reciprocal motion of piston unit develops the square wave oscillation, which being applied to the water hose decreases substantially the friction between water hose and pipe. In horizontal direction nozzle head is able to reach distance over 100 m and in vertical pipe - for instance in high-rise building - it can reach up to 10th floor.

To make the penetration easier, hose reel can be switched on to retract the water hose for a certain length back and then released again. This procedure can be repeated as many times as necessary and is very useful in plugged and/or bended pipes as well as in pipes of big diameter.

When the endpoint is reached, water hose is wound up to the hydraulic hose reel, which is powered from the hydraulic circuit of HPW-pump. At this stage the pipe is actually being cleaned and washed and all dirt, deposits and scalings, removed from the pipe by the rearward water jets.

### STREET WASHING UNITS

HPW-based DYNASET KPL street washing unit transforms any suitable motor vehicle into efficient street washing machine. KPL product range comprises units with power output from 10 up to 125 kW. Actually any commercial vehicle can be used as carrier - pick-up, truck, tractor, skid steer loader, wheel loader etc.

DYNASET KPL street washing unit is ultimately light-weight, WATER SAVING and its washing efficiency is absolutely superior in comparison to obsolete low pressure street washing equipment. Water consumption, related to the washing power, is notably low, so that the area gets dry almost immediately after having been washed. Another point is that the smaller water tank will be sufficient with HPW-pump and re-filling of it takes less time. Suitable KPL street washing unit is to be chosen according to available hydraulic power and your washing task.

Basic KPL equipment kit includes HPW-pump, street washing pipe (L = 1250—2800 mm) with positioning device and frame, water tank and all necessary hoses, control valves and couplings. Length of street washing pipe as well as number and size of nozzles, should be with sufficient precision fitted to the water output of your HPW-pump.

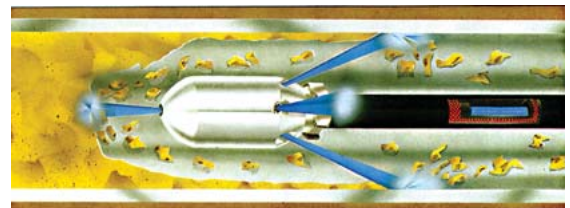

DYNASET Oy offers a comprehensive range of special nozzles and nozzle heads for pipe cleaning, ice melting, root cutting etc.

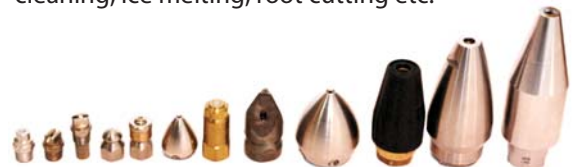

## ...BASIC APPLICATIONS OF HPW-PUMPS

### STREET WASHING UNITS

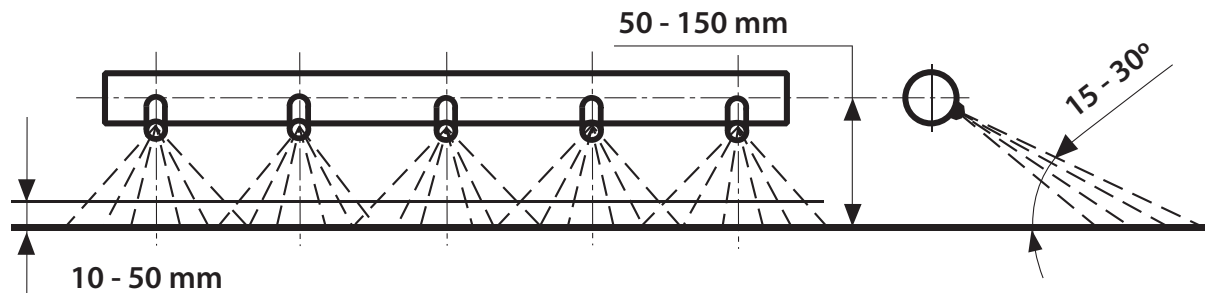

When adjusting on-position, the street washing pipe should be brought down horizontally as close as possible to the roadway. An operator should be careful, though most KPL-types are provided with support wheel in order to prevent street washing pipe from damage. Street washing pipe should be positioned in relation to surface to be washed so, that each water jet would meet its adjoiners at a distance of 10 - 50 mm from it (refer to the drawing above). The kind of paving and surface unevenness should be taken into account as well. It is kept in mind, that positioning the street washing pipe to high would cause washing power loss up to 50 %.

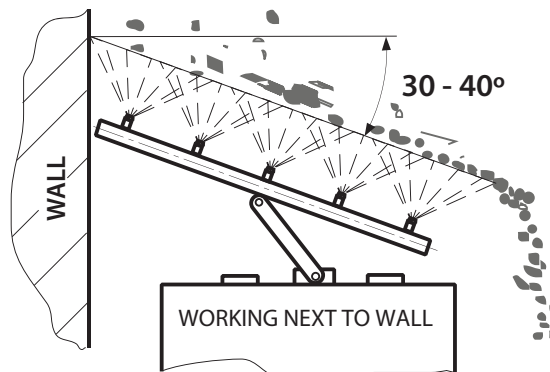
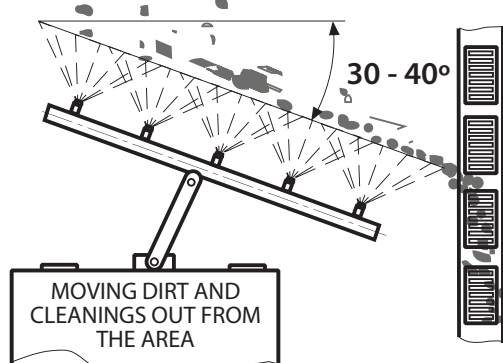

The steering angle of street washing pipe is determined by direction, where the dirt is being moved to. The angle of 30 - 40° is proved to be most effective - refer to the above sketches. High pressure water jets work as dozer blade, moving dirt and cleanings along the street washing pipe to its other end and further aside.

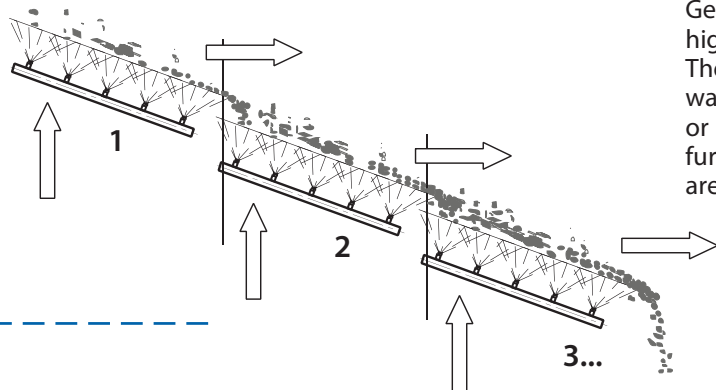

Generally, it is recommended to start job from the highest point of area to be washed. The dirt and cleanings are to be run directly in to the waste water channels when cleaning narrow lanes, or ridged at the driving lane side to be moved further at next driving and so forth, until the whole area will be cleaned.

## HYDRAULIC FLUIDS

Wide range of standard hydraulic fluids can be used with the DYNASET hydraulic equipment.

Subject to the operating temperature, following mineral hydraulic oils are recommended:

ISO VG 32 for oil's operation temperature up to 70 °C;

ISO VG 46 for oil's operation temperature up to 80 °C;

ISO VG 68 for oil's operation temperature up to 90 °C.

Synthetic and bio-oils can be used as well if their viscosity characteristics and lubricating efficiency are corresponding to above mineral oils. Automatic transmission fluids and even engine oils can be used, if they are allowed to be used in hydraulic system of your carrier machine.

Prior to use special hydraulic fluids a with DYNASET equipment, please be kindly requested to contact nearest DYNASET representative for an advice.

## PUMPING FLUIDS

Most of liquids, which can be transferred by pumping, can be pumped also with HPW-pump.

Water based fluids and seawater can be pumped without any special arrangements, however the pump **MUST BE FLUSHED AND CLEANED THOROUGHLY** after a working shift with clean sweet water. Same rule applies to pumping of gelating and depositing fluids - after having done your job, flush HPW-pump with clean water or suitable solvent. Solvents, fuels and oils can be pumped without any special arrangements.

Fluids with abrasives or high content of solids can be pumped as well, but should be kept in mind, that HPW-pump's service lifetime is considerably shortened. Pls. note that DYNASET HDF-pump series is especially designed for pumping of abrasive fluids.

When HPW-pump is going to be used as a self-priming unit with a special or high viscosity liquid, the flow and self-priming conditions should be valuated. If the self-priming property can not be reached, pumping liquid is to be fed with certain pressure (refer to the TECHNICAL SPECIFICATIONS), or the pump should be used at lower hydraulic flow.

Furthermore, if pumping solution is aggressive to NBR-rubber, special seals must be used.

HPW-models made of special materials or with coated parts are available by request.

## MAINTENANCE

Due to small number of moving parts, in normal operating conditions HPW-pump does not require any other service, except replacement of sealings or occasionally of water valves, which depends on content of abrasives in pumping fluid, as well as on cleanliness of hydraulic oil.

Check constantly whether the fluid dropping from pump's leakage detectors is growing and replace sealing in proper time to exclude intermixing of hydraulic oil and pumping fluid.

To enable the easy surveillance, pump should be kept clean.

**WHEN CARRYING OUT ANY DISASSEMBLING OR REPAIR OF HPW-PUMP, ABSOLUTE CLEANLINESS MUST BE MAINTAINED TO ENSURE RELIABLE AND TROUBLE-FREE OPERATION OF YOUR EQUIPMENT.**

**PRODUCT DISPOSAL**

Conform to waste legislation, regulations and recommendations in waste disposal and waste recycling issued by local authorities.

**1. Precondition:**

- Product is permanently useless or beyond repair.
- Before transportation get off all used agent (oil, cooling liquid) and dirty filters.

Items requiring special handling can normally be done by authorized waste management facility, if not:

- Separating the base materials, iron, copper, steel, electronics, removing paint, polyester resin, and insulation tape and/or plastics residues from all components.
- This 'waste material' can now be recycled.

**2. Deliver the recycling and waste material to waste management facility.**

Note! Customer can send the DYNASET equipment for reuse or recycling to the Dynaset Oy or to other location determinate by Dynaset representative.

- Customer pays shipping cost.
- Equipment must be adequately packed for shipment.
- Shipment documents must contain purchaser's name, contact information, equipment type and serial number.



**TROUBLESHOOTING****HPW-PUMP DOES NOT PRODUCE WATER FLOW**

SYMPTOM	CAUSE	ACTION
<b>1.1 HPW-PUMP DOES NOT WORK</b>	1.1.1 Too small hydraulic flow or no hydraulic flow at all.  1.1.2 Hydraulic pressure too low.  1.1.3 Hydraulic flow reversed.  1.1.4 Hydraulic piston damaged mechanically.	1.1.1 Enable or adjust the hydraulic flow.  1.1.2 Adjust the hydraulic pressure.  1.1.3 Check and reconnect hydraulic hoses. Pressure hose should be connected to P-port and return hose to T-port.  1.1.4 Replace damaged part.
<b>1.2 HPW-PUMP WORKS, BUT DOES NOT DELIVER WATER FLOW.</b>  <b>Models with water pressure unloader valve.</b>	1.2.1 Water intake and pressure valves are open (jammed with debris) or damaged.  1.2.2 Regulator's unloader valve opens from intake to pressure.	1.2.1 Check water valves and clean them thoroughly or replace when damaged.  1.2.2 Check the valve and repair failure.
<b>1.3 HPW-PUMP DOES NOT RECEIVE PUMPING FLUID</b>	1.3.1 Intake hose detached or hose breathes.  1.3.2 Water supply line clogged.  1.3.3 Suction head too high.	1.3.1 Check and fix the hose and connectors.  1.3.2 Check strainer or water filter and clean thoroughly.  1.3.3 Check the performance with pressurized water supply when possible.
<b>1.4 WATER PRESSURE LINE BLOCKED.</b>  <b>Models with water pressure unloader valve.</b>	1.4.1 Nozzle clogged.  1.4.2 Regulator's check valve damaged, pressure line blocked.	1.4.1 Check the nozzle and clean thoroughly.  1.4.2 Check the valve and repair failure.

**TROUBLESHOOTING**

<b>2</b> <b>WATER FLOW RATE TOO SMALL</b>	<p>2.1 Insufficient hydraulic flow or pressure.</p> <p>2.2 Nozzle of your pressure tool undersized.</p> <p>2.3 Pressure loss in delivery hose.</p>	<p>2.1 Adjust the hydraulic flow to the demanded level at required pressure.</p> <p>2.2 Verify the nozzle sizing and replace with proper one.</p> <p>2.3 Verify the hose sizing and replace with proper one.</p>
<b>3.</b> <b>WATER PRESSURE TOO LOW</b>	<p>3.1 Insufficient hydraulic pressure or flow.</p> <p>3.2 Nozzle of pressure tool oversized.</p> <p>3.3 Wear-out of nozzle.</p> <p>3.4 Insufficient water supply.</p> <p>3.5 Water pressure unloader valve set too low.</p>	<p>3.1 Adjust the hydraulic pressure to the demanded level at required hydraulic oil flow. Pressure loss should be minimized - do not use hoses of too small diameter or/and of an excessive length.</p> <p>3.2 Verify the nozzle sizing and replace with a proper one.</p> <p>3.3 Replace the nozzle.</p> <p>3.4 Check and fix the problem. Use pressurised water supply if available.</p> <p>3.5 Check and re-adjust to specification.</p>
<b>4.</b> <b>INTENCE PULSATING OF WATER PRESSURE</b>	<p>4.1 Some of water intake and pressure valves are open or damaged.</p> <p>4.2 Water intake line breathes causing pump cavitation.</p> <p>4.3 Water intake line's diameter to small, resulting in pump cavitation.</p> <p>4.4 Excessive hydraulic flow, when HPW-pump runs too fast.</p>	<p>4.1 Check water valves, clean thoroughly or repair.</p> <p>4.2 Check water intake line and fix the problem.</p> <p>4.3 Verify the hose sizing and replace with proper one.</p> <p>4.4 Adjust the hydraulic flow to the demanded level.</p>

## TROUBLESHOOTING

<p>5. CLOSING THE WATER PRESSURE LINE DOES NOT DROP PRESSURE TO FREE CIRCULATION MODE.</p> <p>Hydraulic system starts to run through the pressure relief valve, emitting excessive heat.</p> <p><b>Models with water pressure unloader valve.</b> →</p>	<p>5.1 Insufficient hydraulic pressure in relation to pumping fluid pressure, adjusted with water pressure unloader valve.</p> <p>5.2 Defective water pressure unloader valve.</p>	<p>5.1 Adjust the hydraulic pressure up as much as necessary to enable proper operation of water pressure unloader valve. Note that the maximum hydraulic pressure should not be overrun !</p> <p>If boosting the hydraulic pressure is not possible, the water unloader pressure setting should be dropped.</p> <p>5.2 Repair or replace water pressure unloader valve.</p>
---	--	--

<p>6. <b>LEAKAGES</b></p>	<p>6.1 Hydraulic oil leakages.</p> <p>6.2 Pumping fluid leakages.</p> <p>6.3 Hydraulic-pumping fluid commixture dropping from leakage detecting bores.</p>	<p>6.1 Check the tightness of component mating, tighten screws. Replace when necessary sealings of pump's mated surfaces. Check and tighten/replace couplings.</p> <p>6.2 Check the tightness of component mating, tighten screws. Replace when necessary sealings of pump's mated surfaces. Check and tighten/replace couplings.</p> <p>6.3 If the draining from leakage detectors exceeds rate of 10 drops per minute, pump's sealings should be replaced.</p> <p>The rule applies to dropping of hydraulic fluid, pumping fluid and their commixture.</p>
-------------------------------	--	--

**TECHNICAL SPECIFICATIONS**

HPW-PUMP	OUTPUT CHARACTERISTICS (pumping fluid)			HYDRAULIC POWER REQUIREMENTS		
	FLOW max.	PRESSURE max.	POWER	FLOW	PRESSURE operating	maximum
	l/min	bar	kW	l/min	$\Delta p$ , bar	bar
HPW 200/30-45	30	200	10	45	185	210
HPW 420/20-50	20	420	14	50	190	210
HPW 220/50-70	50	220	18.5	70	180	210
HPW 520/30-85	30	520	26	85	190	210
HPW 90/150-85	150	90	22.5	85	190	210
HPW 180/90-115	90	180	27	115	190	210
HPW 460/50-115	50	460	38	120	240	250
HPW 130/180-140	180	130	39	140	240	250
HPW 800/30-140	30	800	40	140	210	210
HPW1000/30-140	30	1000	50	140	260	280
HPW 1200/100-390	100	1200	200	390	350	350
HPW 1600/15-140	15	1600	40	140	230	250
HPW 300/300-350	300	300	150	350	300	310



**MANUFACTURER'S LIMITED WARRANTY****1. Warranty coverage**

All hydraulic accessories manufactured by DYNASET OY are subject to the terms and conditions of this limited warranty. Products are warranted to the original purchaser to be free from defects in materials or workmanship. Exclusions from warranty are explained in item 8.

**2. Beginning of warranty period**

Warranty period begins from the delivery date of the product. Delivery is considered to be done on the date when installation has been accomplished or purchaser has taken the product in use. Product is considered as taken in use at the date when DYNASET OY has delivered the product to purchaser, unless separately agreed otherwise by written agreement.

**3. Warranty period**

Warranty period is twenty four (24) months based on maximum of 2000 hours usage during this time period. In cases where the system is provided complete with certain special components (e.g. drive unit), those components are considered as a subject to their manufacturer's warranty.

**4. Warranty procedures**

Immediately upon identifying a problem which purchaser believes to be a failure subject to the product's limited warranty, purchaser must contact primary to the seller of the product. Contact must be made as soon as possible, latest thirty (30) days after the problem was identified. Seller and/or manufacturer technical staff determines the nature of the problem primarily by phone or e-mail. Purchaser commits to give necessary information and to perform routine diagnostic procedures in order to determine the nature of the problem and necessary procedures.

**5. Warranty repairs**

If the product is found to be defective during the warranty period, DYNASET OY will, at its option, either repair the product, author it to be repaired at its authorized workshop or exchange the defective product. If the product must be repaired elsewhere than premises of DYNASET OY or authorized workshop, all costs excluded from this warranty (traveling and waiting hours, daily allowance, traveling expenses and uninstallation/reinstallation costs) will be charged from the purchaser.

If the problem is not covered by this limited warranty, DYNASET OY has the right to charge purchaser of troubleshooting and repairing.

**6. Delivery terms of warranty repair**

If the product is found possible to be defective under this limited warranty and it needs to be repaired, DYNASET OY gives Warranty Return Number (WRN). Items being returned must be shipped, at the purchaser's cost, adequately packed for shipment, to the DYNASET OY or to other location authored by DYNASET OY.

Shipment documents must contain:

- Purchaser's name and contact information
  - Receipt of original purchase
  - WRN code
  - Problem description
- 7. Warranty of repaired product**  
Warranty period of the product repaired under this limited warranty continues to the end of original warranty period.
- 8. Exclusions from warranty**  
This warranty shall not apply to:
- a. Failures due to normal wear and tear, improper installation, misuse, abuse, negligence, purchaser selection of improper product to intended use, accident, improper filtration of hydraulic oil or intake water or lack of maintenance
  - b. Cost of maintenance, adjustments, installation or startup
  - c. Coating, hydraulic oil, quick couplings and interconnection hoses (internal or external to system assemblies)
  - d. Products altered or modified in a manner not authorized by DYNASET OY in writing
  - e. Products which have been repaired during warranty period by others than DYNASET OY or its authorized workshop
  - f. Costs of any other damage or loss, whether direct, indirect, incidental, special or consequential, arising out of the use of, or the inability to use, the product
  - g. Telephone or other communications expense
  - h. Product that is used in exceptional conditions, considered to cause excessive wear and tear
  - i. Faults caused by nature phenomenon's like flood, thunder, etc.

© DYNASET OY, all rights reserved

## DECLARATION OF CONFORMITY

We hereby declare that the below-reference product design and manufacturing are in conformity with the provisions in the Council Directive on mutual approximation of laws of the Member States on the safety of machines.

- Machine directive 2006/42/EC
- LVD directive 2006/95/EC
- EMC directive 2004/108/EC.
- SFS 135-1 Machines and machinery. Electrical equipment and systems.

Apply conformity standards:

- EN ISO 4413: EN ISO 4413:2010 Hydraulic fluid power - General rules and safety requirements for systems and their components.
- Safety of Machinery. Electrical equipment of machines. SFS 60204 SFS-EN-60204-1-6. Protection against electric shock. SFS-EN-60204-1-8. Equipotential bonding.  
Electrical assemblies are fitted with these standards to meet the requirements.

If device has changed by someone other than at the hands of manufacturer or his permission, this declaration is not valid.

**PRODUCT:** HYDRAULIC HIGH PRESSURE PUMP

**ALL MODEL NUMBERS:** HPWXXXXXXXX-XXXXXXXX-XXXXXX-XXXXXX-XXXXXX

YLÖJÄRVI 01.01.2014

**DYNASET Oy**



Timo Nieminen  
R&D Manager

